

Programmable Digital Controller E5AR-T/E5ER-T

A new High-speed, High-precision Digital Controller that is Programmable!

- Create up to 32 programs with up to 256 segments total.
- Coordinated operation for up to four channels with one Digital Controller.
- 0.01°C; High resolution for Pt input.
- High-speed sampling at 50 ms.

 Refer to "Precautions" on pages 24 and 25.



■ Features

Up to 32 Programs

You can create up to 32 programs with up to 8 segments each, or you can create up to 8 programs with up to 32 segments each. Either way, you get up to a total of 256 segments of programming. This feature is ideal for testing equipment to make a variety of settings.

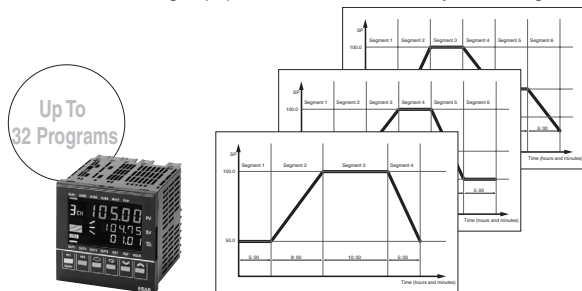

Coordinated Operation for Up to Four Channels with One Digital Controller

Up to four channels are supported for analog control in a compact-sized body to contribute to downsizing control panels.

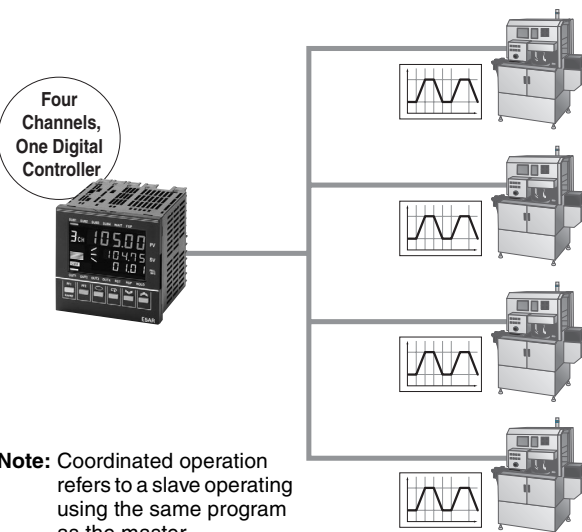

Note: Coordinated operation refers to a slave operating using the same program as the master.

High-speed and High-resolution Performance

Sample at the high speed of 50 ms for 4 channels to achieve stable control even for items requiring high-speed response. And, the resolution is 0.01°C for a Pt input. Temperature, humidity, and other factors for ambient testing equipment can be measured, variations detected, and data logged at a high resolution.

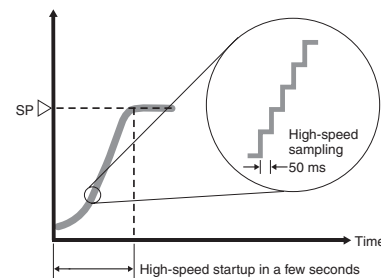

Easy Settings from a Computer Using the CX-Thermo

The CX-Thermo setting software (version 3.1 or higher) lets you set, edit, and transfer parameters all at once.

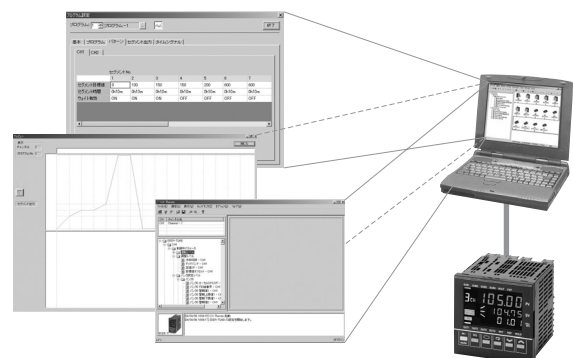

RoHS Compliance for World-wide Application

Available Soon: It will soon be possible to easily setup and monitor screens online using the SAP Library.

Product Lineup

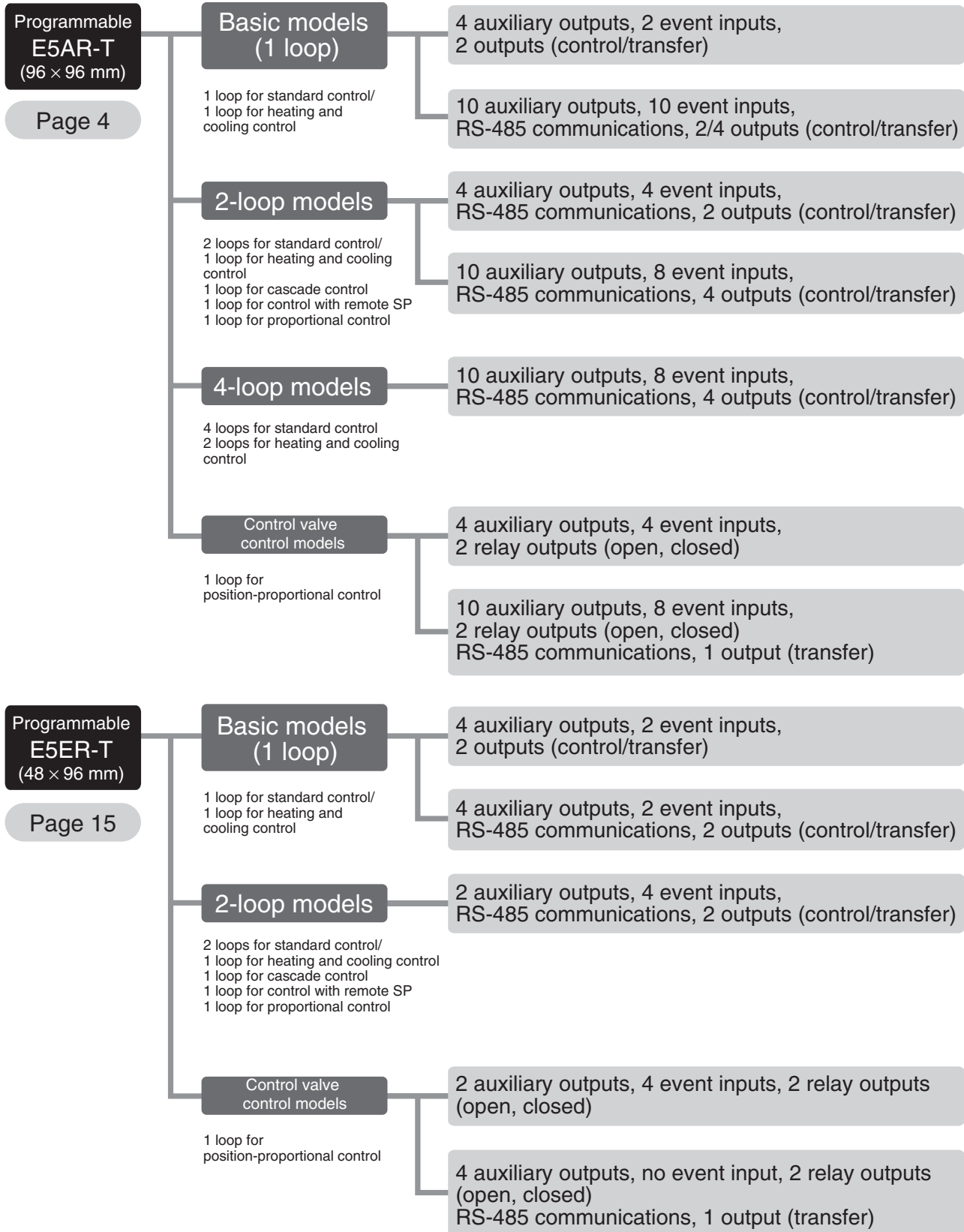

■ Peripheral Devices

Connection Example for E5□R Series, Temperature Sensors, and SSRs

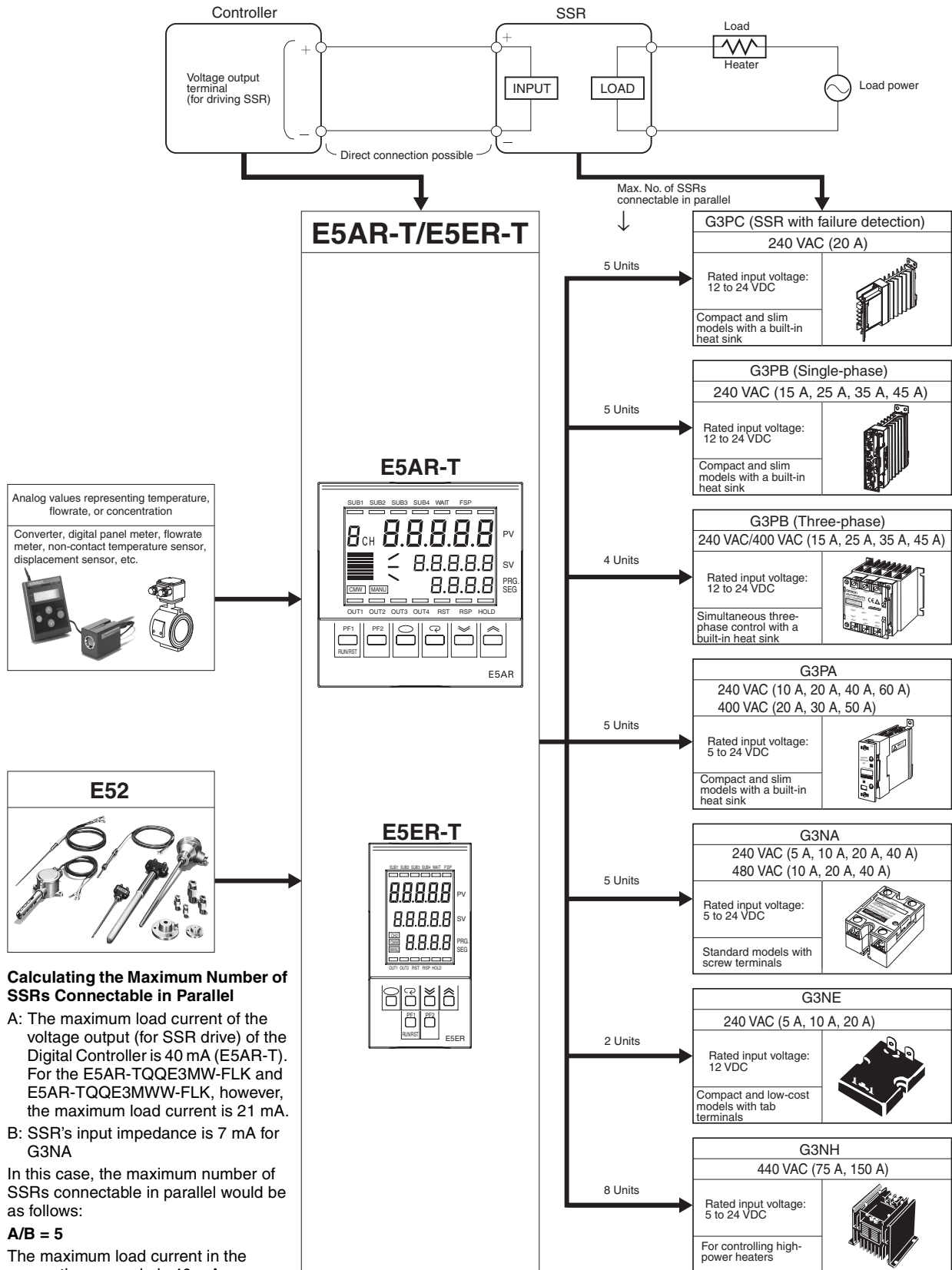

Programmable Digital Controller E5AR-T

A new High-speed, High-precision Digital Controller that is Programmable!

- Create up to 32 programs with up to 256 segments total.
- Coordinated operation for up to four channels with one Digital Controller.
- 0.01°C High resolution for Pt input.
- High-speed sampling at 50 ms.
- Settings easily made from a computer using the CX-Thermo.
- RoHS compliance for world-wide application.



 Refer to "Precautions" on pages 24 and 25.



Model Number Structure

Model Number Legend

E5AR-T -

1 2 3 4 5 6 7 8 9

1. Control method

Blank: Standard or heating/cooling control
P: Position proportional control

2. Output 1

R: NO relay output + NO relay output
Q: Pulse output/current output + pulse output
C: Current output + current output

3. Output 2

R: NO relay output + NO relay output
Q: Pulse output/current output + pulse output
C: Current output + current output

4. Auxiliary Outputs

Blank: None
4: NO relay output + NO relay output
E: 5 transistor outputs + 5 transistor outputs

5. Communications

Blank: None
3: RS-485 communications

6. Optional function

Blank: None
D: 4 event inputs
M: 4 event inputs + 4 event inputs

7. Input 1

B: Multi-input and 2 event inputs
F: Multi-input and FB (Potentiometer input)
W: Multi-input and multi-input

8. Input 2

Blank: None
W: Multi-input and multi-input

9. Other

FLK: CompoWay/F communications

Note: Be sure to read the precautions for correct use and other precautions in the following user's manual before using the Digital Controller.

E5AR/ER Programmable Digital Controller User's Manual (Cat. No. Z182)

A PDF version of the user's manual can be downloaded from the following web site:
OMRON Industrial Web <http://www.fa.omron.co.jp/>

Ordering Information

■ Digital Controllers

Programmable Digital Controllers

Size	Control type	Control mode	Outputs (control/transfer)	Optional functions			Model		
				Auxiliary outputs (SUB)	Event inputs	Serial communications			
96 × 96 mm	Basic control (1 loop)	Standard control Heating and cooling control	2 (pulse + pulse/current)	4	2	None	E5AR-TQ4B		
			2 (current + current)				E5AR-TC4B		
			2 (pulse + pulse/current)				RS-485	E5AR-TQ43B-FLK (See note 2.)	
			2 (current + current)					E5AR-TC43B-FLK (See note 2.)	
			2 (pulse + pulse/current)				10 (See note 3.)	10	E5AR-TQE3MB-FLK (See note 2.)
			2 (current + current)						E5AR-TCE3MB-FLK (See note 2.)
	4 (pulse + pulse/current + 2 current)		E5AR-TQCE3MB-FLK						
	2-loop control	2-loop standard control Single-loop heating and cooling control Single-loop cascade control Single-loop control with remote SP Single-loop proportional control	2 (pulse + pulse/current)	4	4	RS-485	E5AR-TQ43DW-FLK (See note 2.)		
			2 (current + current)				E5AR-TC43DW-FLK (See note 2.)		
			4 (2 pulse + pulse/2 current)	10 (See note 3.)	8		E5AR-TQQE3MW-FLK		
			4 (4 current)	10 (See note 3.)	8		RS-485	E5AR-TCCE3MWW-FLK	
								4 (2 pulse + pulse/2 current)	E5AR-TQQE3MWW-FLK (See note 2.)
Relay outputs (1 open, 1 closed)			4	4	None		E5AR-TPR4DF		
Relay outputs (1 open, 1 closed) + 1 current	10 (See note 3.)	8	RS-485	E5AR-TPRQE3MF-FLK					
4-loop control	4-loop standard control 2-loop heating and cooling control (See note 4.)	4 (4 current)	10 (See note 3.)	8	RS-485	E5AR-TCCE3MWW-FLK			
		4 (2 pulse + pulse/2 current)				E5AR-TQQE3MWW-FLK (See note 2.)			
Control valve control (1 loop)	Single-loop position-proportional control	Relay outputs (1 open, 1 closed)	4	4	None	E5AR-TPR4DF			
		Relay outputs (1 open, 1 closed) + 1 current	10 (See note 3.)	8	RS-485	E5AR-TPRQE3MF-FLK			

- Note 1:** Specify the power supply specifications when ordering. Model numbers for 100 to 240 VAC are different from those for 24 VAC/VDC.
2: These models are for 100 to 240 VAC only.
3: The outputs are transistor output.
4: Only for coordinated operation. (A separate program cannot be set for each channel.)

Inspection Results

If an inspection report is required, it can be ordered at the same time as the Digital Controller using the following model number.

Inspection Report (Order Separately)

Model
E5AR-K

■ Accessories (Order Separately)

Terminal Cover

Descriptions	Model
Terminal Cover for E5AR	E53-COV14

Unit Label Sheet

Model
Y92S-L1

Rubber Packing

Model
Y92S-P4

Note: The Rubber Packing is provided with the Digital Controller.

Specifications

■ Ratings

Supply voltage (See note 2.)	CE marking	100 to 240 VAC, 50/60 Hz	24 VAC, 50/60 Hz; 24 VDC
	UL certification	100 to 120 VAC, 50/60 Hz	24 VAC, 50/60 Hz; 24 VDC
Operating voltage range		85% to 110% of rated supply voltage	
Power consumption		22 VA max. (with maximum load)	15 VA/10 W max. (with maximum load)
Sensor input (See note 3.)		Thermocouple: K, J, T, E, L, U, N, R, S, B, W Platinum resistance thermometer: Pt100 Current input: 4 to 20 mA DC, 0 to 20 mA DC (including remote SP input) Voltage input: 1 to 5 VDC, 0 to 5 VDC, 0 to 10 VDC (including remote SP input) (Input impedance: 150 Ω for current input, approx. 1 MΩ for voltage input)	
Control output	Voltage (pulse) output	12 VDC, 40 mA max. with short-circuit protection circuit (E5AR-TQQE3MW-FLK: 21 mA max.)	
	Current output	0 to 20 mA DC, 4 to 20 mA DC; load: 500 Ω max. (including transfer output) (Resolution: Approx. 54,000 for 0 to 20 mA DC; Approx. 43,000 for 4 to 20 mA DC)	
	Relay output	Position-proportional control type (open, closed) N.O., 250 VAC, 1 A (including inrush current)	
Auxiliary output		Relay Output N.O., 250 VAC, 1 A (resistive load) Transistor Output Maximum load voltage: 30 VDC; Maximum load current: 50 mA; Residual voltage: 1.5 V max.; Leakage current: 0.4 mA max.	
Potentiometer input		100 Ω to 2.5 kΩ	
Event input	Contact	Input ON: 1 kΩ max.; OFF: 100 kΩ min.	
	No-contact	Input ON: Residual voltage of 1.5 V max.; OFF: Leakage current of 0.1 mA max. Short-circuit: Approx. 4 mA	
Remote SP input		Refer to the information on sensor input.	
Transfer output		Refer to the information on control output.	
Control method		2-PID or ON/OFF control	
Setting method		Digital setting using front panel keys or setting using serial communications	
Indication method		7-segment digital display and single-lighting indicator Character Height PV display: 12.8 mm; SV display: 7.7 mm; MV display: 7.7 mm	
Other functions		Depends on model.	
Ambient operating temperature		-10 to 55°C (with no icing or condensation) For 3 years of assured use: -10 to 50°C (with no icing or condensation)	
Ambient operating humidity		25% to 85%	
Storage temperature		-25 to 65°C (with no icing or condensation)	

Note 1: Do not use an inverter output as the power supply. (Refer to page 25.)

Note 2: The supply voltage (i.e., 100 to 240 VAC or 24 VAC/VDC) depends on the model. Be sure to specify the required type when ordering.

Note 3: The Controller is equipped with multiple sensor input. Temperature input or analog input can be selected with the input type setting switch. There is basic insulation between power supply and input terminals, power supply and output terminals, and input and output terminals.

■ Input Ranges

Platinum Resistance Thermometer, Thermocouple, Current, or Voltage Input

Input type	Platinum resistance thermometer	Thermocouple														Current		Voltage		
		Pt100														mA		V		
Name	Pt100	K	J	T	E	L	U	N	R	S	B	W (W/Re 5-26)	15	16	17	18	19			
Temperature range (°C)		850.0	1300.0	850.0	500.0	400.0	400.0	600.0	850.0	400.0	1300.0	1700.0	1700.0	1800.0	2300.0					
		-200.0	-150.0	-200.0	-20.0	-100.0	-20.0	-200.0	0.0	-100.0	-200.0	-200.0	0.0	0.0	100.0	0.0				
Setting	0	1	2	3	4	5	6	7	8	9	10	11	12	13	14	15	16	17	18	19
Minimum setting unit (SP and alarm)	0.1°C	0.01°C							0.1°C							(Depends on scaling and number of decimal places.)				
Input type setting switch									TC,PT										ANALOG	

Note: The shaded area indicates the setting status at the time of purchase.

■ Characteristics

Indication accuracy	Thermocouple input with cold junction compensation: ($\pm 0.1\%$ of PV or $\pm 1^\circ\text{C}$, whichever is greater) ± 1 digit max. (See note 1.) Thermocouple input without cold junction compensation: ($\pm 0.1\%$ FS or $\pm 1^\circ\text{C}$, whichever is smaller) ± 1 digit (See note 2.) Analog input: $\pm 0.1\%$ FS ± 1 digit max. Platinum resistance thermometer input: ($\pm 0.1\%$ of PV or $\pm 0.5^\circ\text{C}$, whichever is greater) ± 1 digit max. Position-proportional potentiometer input: $\pm 5\%$ FS ± 1 digit max.
Control mode	Standard control (heating or cooling control), heating/cooling control, standard control with remote SP (2-input models only), heating/cooling control with remote SP (2-input models only), cascade standard control (2-input models only), cascade heating/cooling control (2-input models only), proportional control (2-input models only), position-proportional control (control-valve control models only)
Influence of temperature	Thermocouple input (R, S, B, W): ($\pm 1\%$ of PV or $\pm 10^\circ\text{C}$, whichever is greater) ± 1 digit max. Other thermocouple input: ($\pm 1\%$ of PV or $\pm 4^\circ\text{C}$, whichever is greater) ± 1 digit max. *K thermocouple at -100°C max.: $\pm 10^\circ\text{C}$ max. Platinum resistance thermometer: ($\pm 1\%$ of PV or $\pm 2^\circ\text{C}$, whichever is greater) ± 1 digit max. Analog input: ($\pm 1\%$ FS) ± 1 digit max.
Influence of voltage	
Control period	0.2 to 99.0 s (in units of 0.1 s) for time-proportioning control output
Proportional band (P)	0.00% to 999.99% FS (in units of 0.01% FS)
Integral time (I)	0.0 to 3,999.9 s (in units of 0.1 s)
Derivative time (D)	0.0 to 3,999.9 s (in units of 0.1 s)
Hysteresis	0.01% to 99.99% FS (in units of 0.01% FS)
Manual reset value	0.0% to 100.0% (in units of 0.1% FS)
Alarm setting range	-19,999 to 99,999 EU (See note 3.) (The decimal point position depends on the input type and the decimal point position setting.)
Input sampling period	50 ms
Insulation resistance	20 M Ω min. (at 500 VDC)
Dielectric strength	2,000 VAC, 50/60 Hz for 1 min (between charged terminals of different polarities)
Vibration resistance (malfunction)	10 to 55 Hz, 20 m/s ² for 10 min each in X, Y, and Z directions
Shock resistance (malfunction)	100 m/s ² , 3 times each in X, Y, and Z directions
Inrush current	100 to 240-VAC models: 50 A max. 24 VAC/VDC models: 30 A max.
Weight	Controller only: Approx. 450 g; Mounting bracket: Approx. 60 g; Terminal cover: Approx. 30 g
Degree of protection	Front panel: NEMA4X for indoor use (equivalent to IP66); Rear case: IP20; Terminals: IP00
Memory protection	Non-volatile memory (number of writes: 100,000)
Applicable standards	UL 61010C-1, CSA C22.2 No. 1010-1 (Power supply voltage: 100 to 120 VAC): Pollution degree 2/Overvoltage category 2 EN 61010-1 (IEC 61010-1) (Power supply voltage: 100 to 240 VAC): Pollution degree 2/Overvoltage category 2
EMC	EMI: EN61326 Radiated Interference Electromagnetic Field Strength: EN55011 Group 1 Class A Noise Terminal Voltage: EN55011 Group 1 Class A EMS: EN61326 ESD Immunity: EN61000-4-2: 4 kV contact discharge (level 2) 8 kV air discharge (level 3) Electromagnetic Immunity: EN61000-4-3: 10 V/m (amplitude-modulated, 80 MHz to 1 GHz, 1.4 GHz to 2 GHz) (level 3) Burst Noise Immunity: EN61000-4-4: 2 kV power line (level 3) 2 kV output line (relay output) (level 4) 1 kV measurement line, I/O signal line (level 4) 1 kV communications line (level 3) Conducted Disturbance Immunity: EN61000-4-6: 3 V (0.15 to 80 MHz) (level 3) Surge Immunity: EN61000-4-5: 1 kV line to line (power line, output line (relay output)) (level 2) 2 kV line to ground (power line, output line (relay output)) (level 3) Power Frequency Magnetic Field Immunity: EN61000-4-8: 30 A/m (50 Hz) continuous field Voltage Dip/Interrupting Immunity: EN61000-4-11: 0.5 cycle, 100% (rated voltage)

- Note 1:** K-, T-, or N-type thermocouple at -100°C max.: $\pm 2^\circ\text{C}$ ± 1 digit max.
U- or L-type thermocouple: $\pm 2^\circ\text{C}$ ± 1 digit max.
B-type thermocouple at 400°C max.: No accuracy specification.
R- or S-type thermocouple at 200°C max.: $\pm 3^\circ\text{C}$ ± 1 digit max.
W-type thermocouple: ($\pm 0.3\%$ of PV or $\pm 3^\circ\text{C}$, whichever is greater) ± 1 digit max.
- 2:** U- or L-type thermocouple: $\pm 1^\circ\text{C}$ ± 1 digit
R- or S-type thermocouple at 200°C max.: $\pm 1.5^\circ\text{C}$ ± 1 digit
- 3:** "EU" (Engineering Unit) represents the unit after scaling. If a temperature sensor is used, it is either $^\circ\text{C}$ or $^\circ\text{F}$.

■ Communications Specifications

Transmission path connection	Multiple points
Communications method	RS-485 (two-wire, half duplex)
Synchronization method	Start-stop synchronization
Baud rate	9,600, 19,200, or 38,400 bps
Transmission code	ASCII
Data bit length	7 or 8 bits
Stop bit length	1 or 2 bits
Error detection	Vertical parity (none, even, odd) Block check character (BCC): CompoWay/F CRC-16: Modbus
Flow control	None
Interface	RS-485
Retry function	None
Communications buffer	217 bytes
Communications response send wait time	0 to 99 ms, Default: 20 ms

■ Program Control Functions

Number of programs (patterns)	32 (with 8 segments/program)	
Number of segments (steps)	32 (with 8 programs)	
Maximum number of segments	256	
Segment setting method	Time setting (Segment set with set point and time.) Gradient setting (Segment set with set point, gradient, and time.)	
Segment times	0 h 0 min to 99 h 59 min 0 min 0 s to 99 min 59 s 0 min 00.0 s to 99 min 59.9 s	
Alarm group number specifications	Number of groups	4
	Setting method	Set separately for each program.
Reset operation	Select either stopping control or fixed SP operation.	
Startup operation	Select continuing, resetting, manual operation, run mode, or ramp back operation.	
PID groups	Number of groups	8
	Setting method	Set separately for each program (automatic PID group selection also supported).
Alarm SP function	Select from ramp SP and target SP.	
Program status control	Segment operation	Advance, hold, and back
	Program operation	Program repetitions and program links
Wait operation	Wait method	Select from waiting at segment ends and always waiting.
	Wait width setting	Wait width upper limit and lower limit set separately for each program.
	Setting method	ON/OFF setting for each segment
Time signals	Number of outputs	6
	Number of ON/OFF operations	3 each per output
	Setting method	Set separately for each program.
Segment outputs	Number of outputs	10
	Setting method	ON/OFF set for each segment.
Program status output	Program end output (pulse width can be set) Segment number output	
Program startup operation	PV start	Select from segment 1 set point, slope-priority PV start, and time-priority PV start.
	Standby	Standby
Operation end operation	Select from resetting, continuing control at final set point, and fixed SP control.	
Number of event inputs	10 max.	

Wiring Terminals

■ E5AR-T (Programmable Type)

E5AR-TQ4B

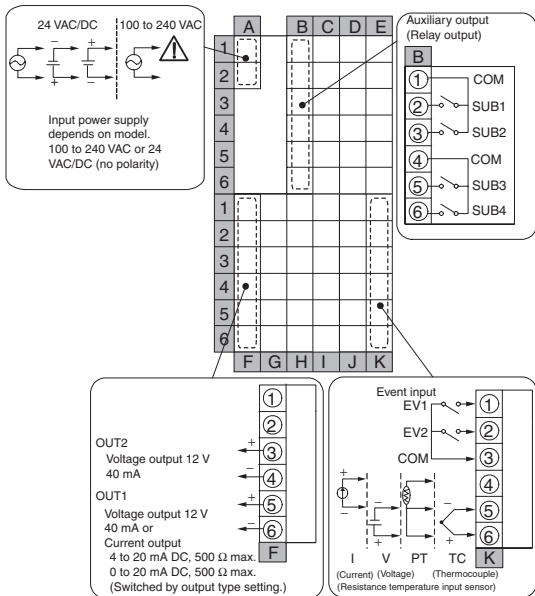

E5AR-TC4B

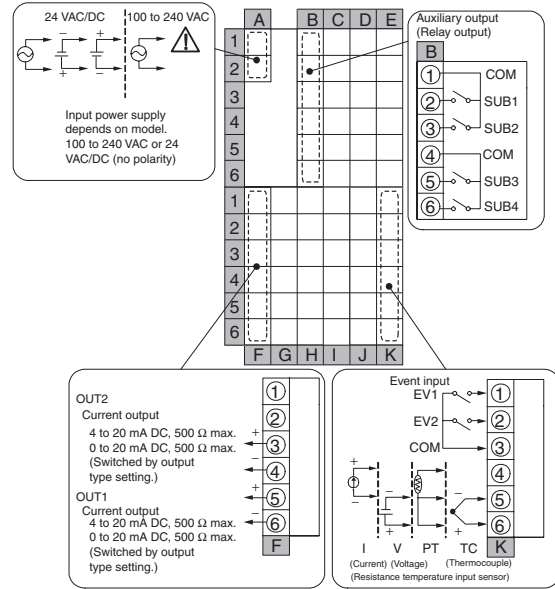

E5AR-TQ43B-FLK

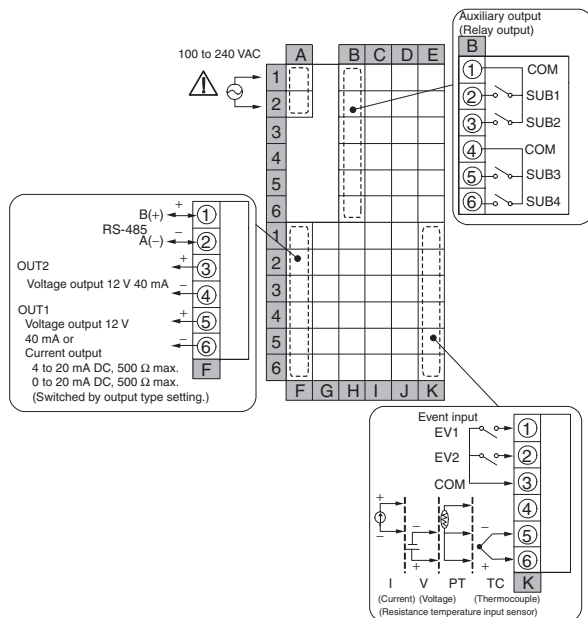

E5AR-TC43B-FLK

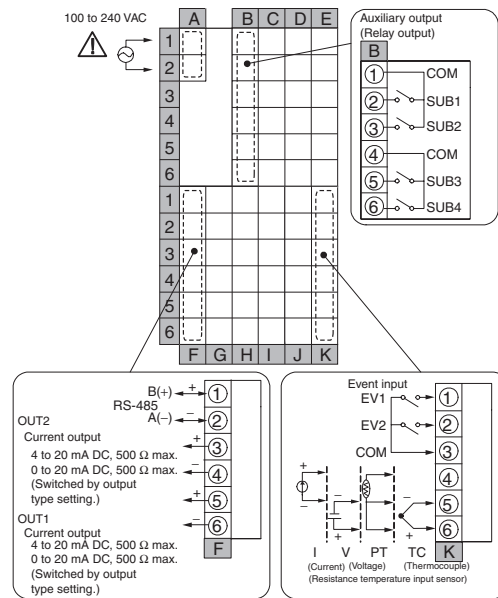

Note

The power supply voltage must be 100 to 240 VAC or 24 VAC/DC for the E5AR-T to comply with CE marking requirements.
The power supply voltage must be 100 to 120 VAC or 24 VAC/DC for the E5AR-T to comply with UL requirements.

E5AR-TQE3MB-FLK

E5AR-TCE3MB-FLK

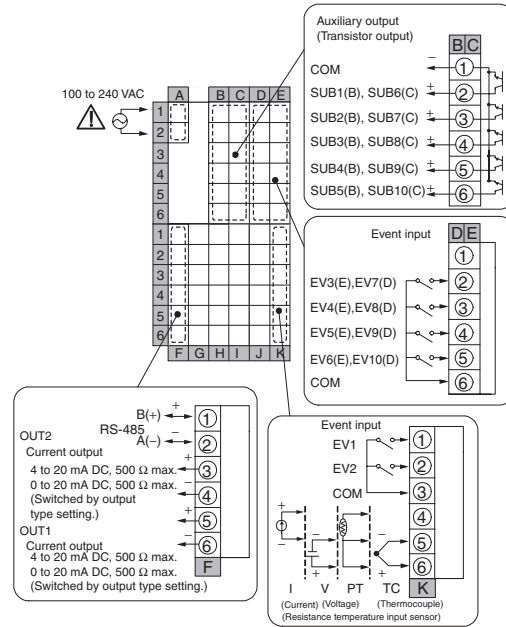
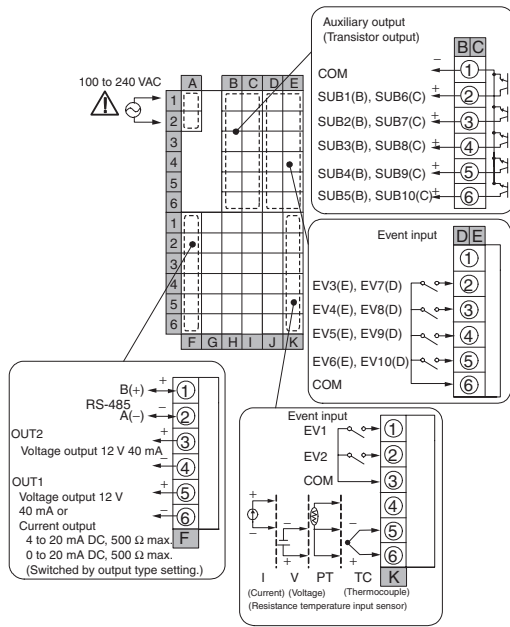

E5AR-TQCE3MB-FLK

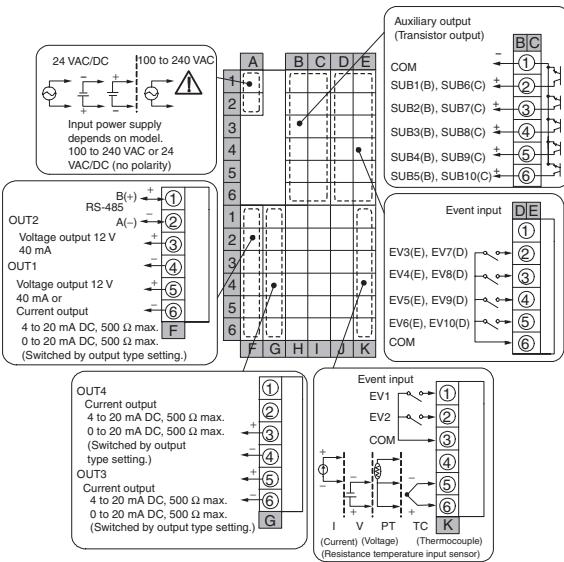

Note The power supply voltage must be 100 to 240 VAC or 24 VAC/DC for the E5AR-T to comply with CE marking requirements.
 The power supply voltage must be 100 to 120 VAC or 24 VAC/DC for the E5AR-T to comply with UL requirements.

E5AR-TQ43DW-FLK (2-loop Control)

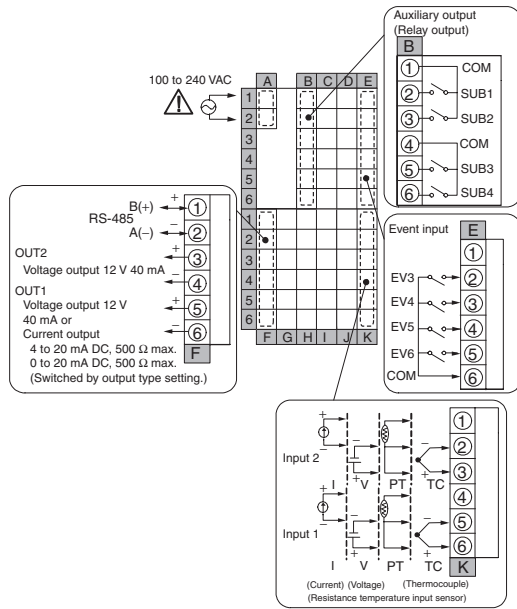

E5AR-TC43DW-FLK (2-loop Control)

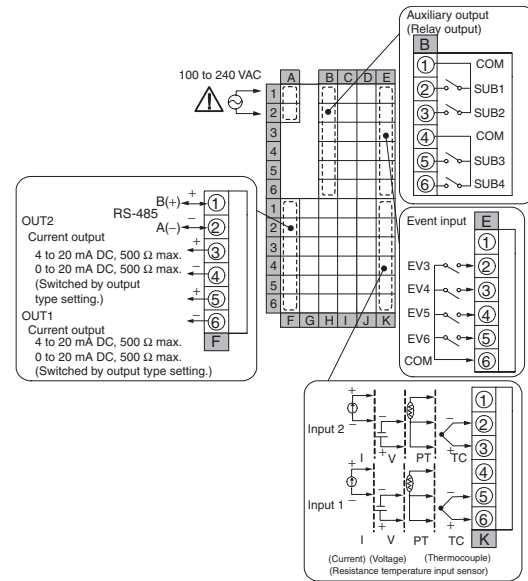

E5AR-TQQE3MW-FLK (2-loop Control)

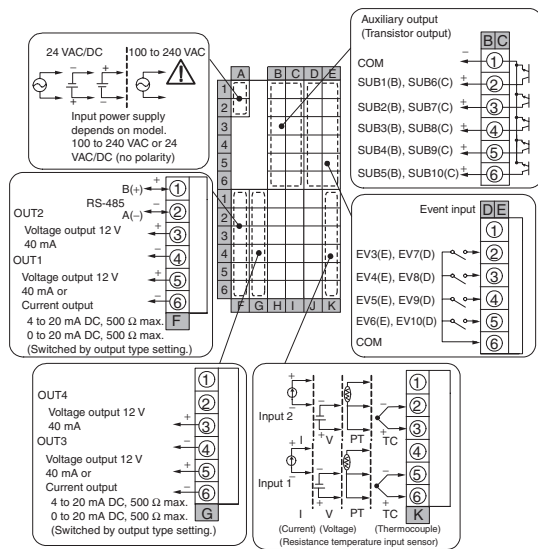

Note The power supply voltage must be 100 to 240 VAC or 24 VAC/DC for the E5AR-T to comply with CE marking requirements. The power supply voltage must be 100 to 120 VAC or 24 VAC/DC for the E5AR-T to comply with UL requirements.

E5AR-TCCE3MWW-FLK (4-loop Control)

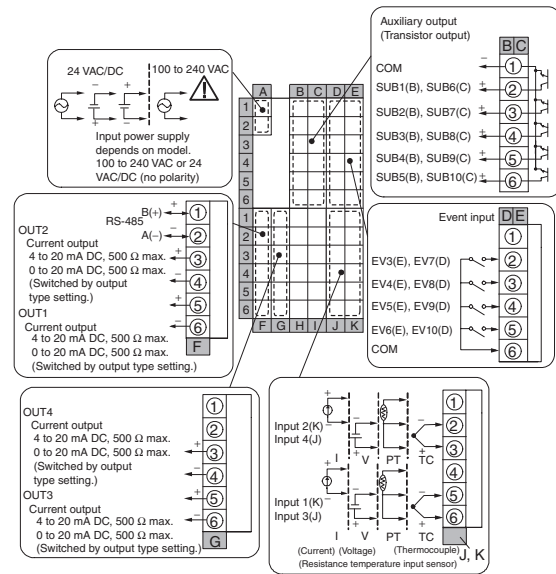

E5AR-TQQE3MWW-FLK (4-loop Control)

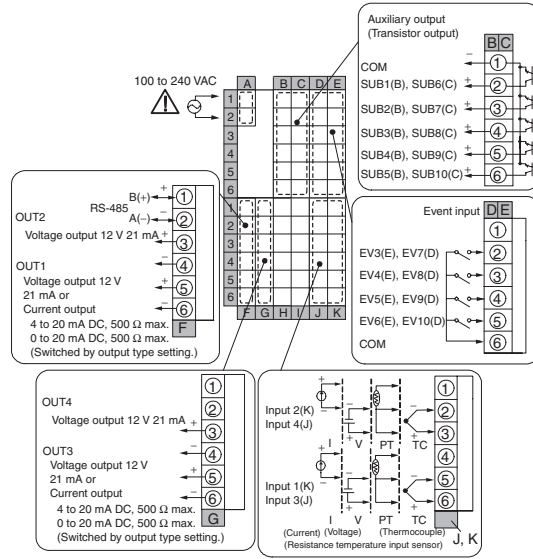

E5AR-TPR4DF

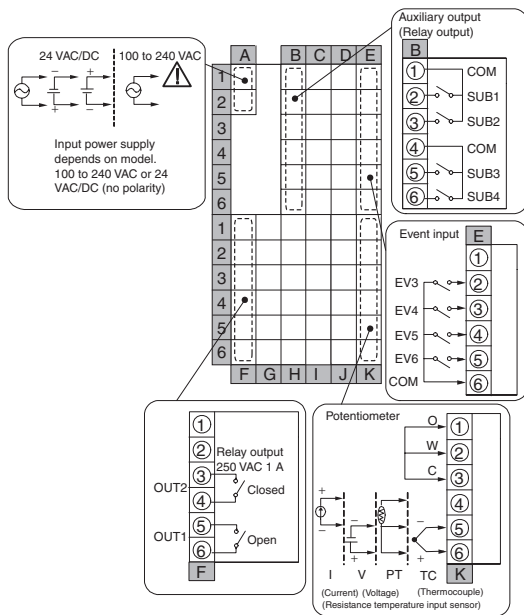

E5AR-TPRQE3MF-FLK

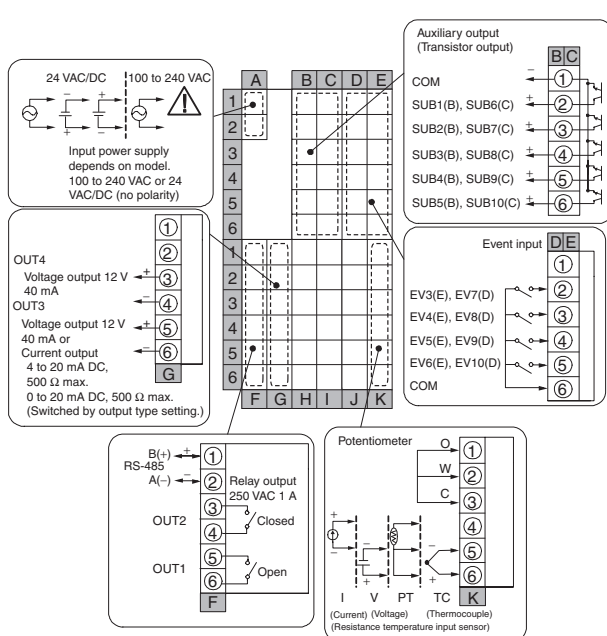

Note The power supply voltage must be 100 to 240 VAC or 24 VAC/DC for the E5AR-T to comply with CE marking requirements. The power supply voltage must be 100 to 120 VAC or 24 VAC/DC for the E5AR-T to comply with UL requirements.

Nomenclature

E5AR-T

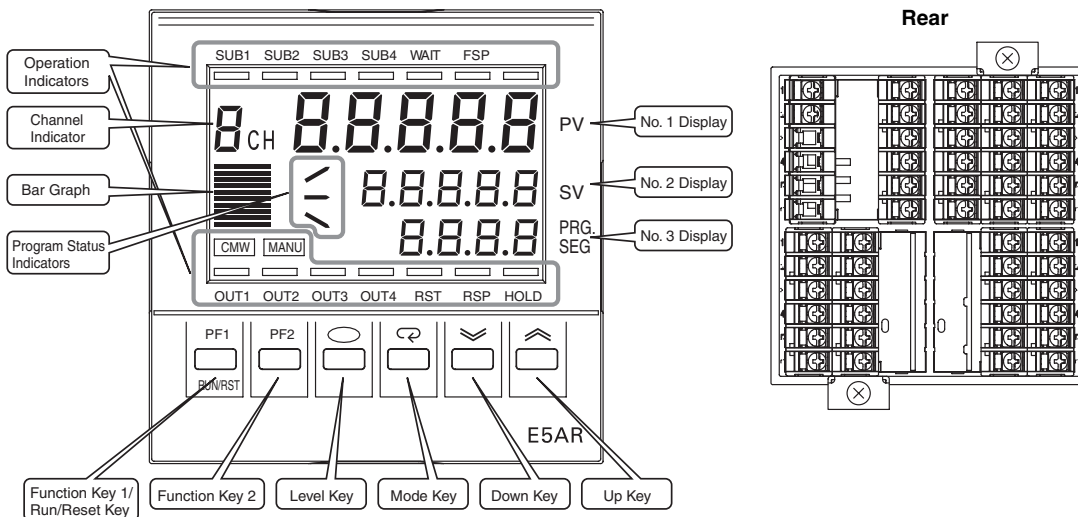

Dimensions

Note: All units are in millimeters unless otherwise indicated.

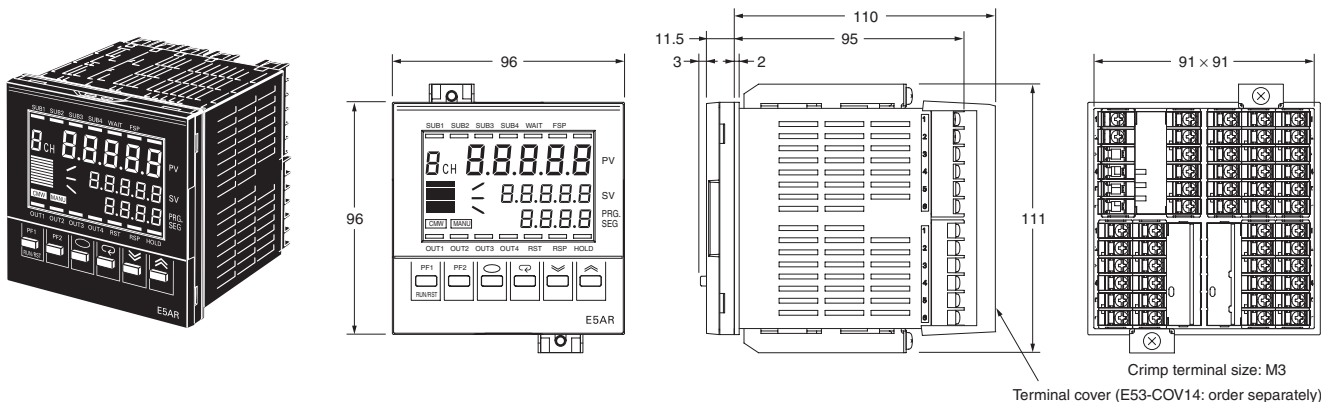

Panel Cutouts

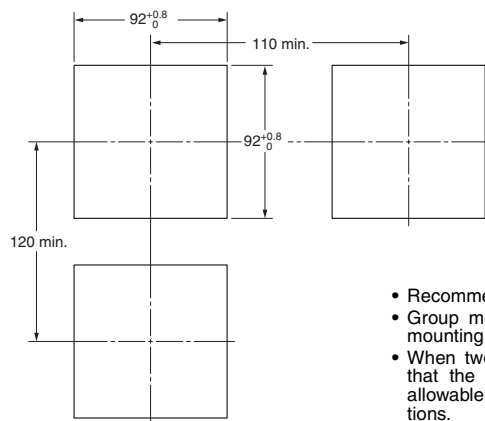

- Recommended panel thickness is 1 to 8 mm.
- Group mounting is not possible. (Maintain the specified mounting space between Controllers.)
- When two or more Controllers are mounted, make sure that the surrounding temperature does not exceed the allowable operating temperature specified in the specifications.

■ Accessories (Order Separately)

Terminal Cover

E53-COV14 (for E5AR)

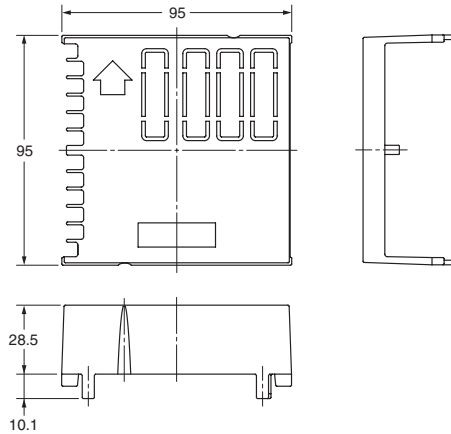
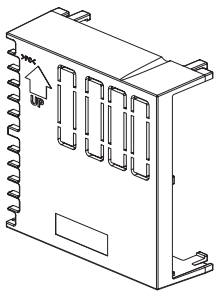

Unit Label Sheet

Y92S-L1

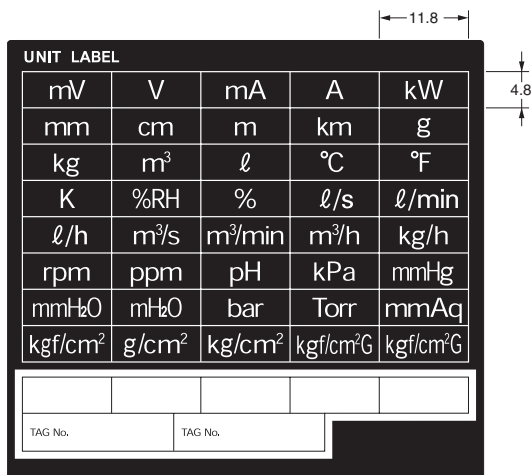

Rubber Packing

Y92S-P4 (for DIN96 × 96)

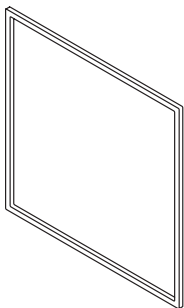

Order the Rubber Packing separately if it becomes lost or damaged. (Refer to page 5.) (Deterioration, shrinking, or hardening of the rubber packing may occur depending on the operating environment. Therefore, periodic replacement is recommended to ensure the level of waterproofing specified in NEMA4. The time for periodic replacement depends on the operating environment. Be sure to confirm this point at your site. Consider one year a rough standard. OMRON shall not be liable for the level of water resistance if the customer does not perform periodic replacement.)

ALL DIMENSIONS SHOWN ARE IN MILLIMETERS.

To convert millimeters into inches, multiply by 0.03937. To convert grams into ounces, multiply by 0.03527.

Ordering Information

■ Digital Controllers

Programmable Digital Controllers

Size	Control type	Control mode	Outputs (control/transfer)	Optional functions			Model
				Auxiliary outputs (SUB)	Event inputs	Serial communications	
48 × 96 mm	Basic control (1 loop)	Standard control Heating and cooling control	2 (pulse + pulse/current)	4	2	None	E5ER-TQ4B
			2 (current + current)				E5ER-TC4B
			2 (pulse + pulse/current)				RS-485
	2-loop control	2-loop standard control Single-loop heating and cooling control Single-loop cascade control Single-loop control with remote SP Single-loop proportional control	2 (pulse + pulse/current)	2 (See Note 2.)	4	RS-485	E5ER-TQT3DW-FLK
			2 (current + current)				E5ER-TCT3DW-FLK
	Control valve control (1 loop)	Single-loop position-proportional control	Relay outputs (1 open, 1 closed)	2 (See Note 2.)	4	None	E5ER-TPRTDF
Relay outputs (1 open, 1 closed) + 1 current			4	None			RS-485

Note 1: Specify the power supply specifications when ordering. Model numbers for 100 to 240 VAC are different from those for 24 VAC/VDC.

2: The outputs are transistor output.

Inspection Results

If an inspection report is required, it can be ordered at the same time as the Digital Controller using the following model number.

Inspection Report (Order Separately)

Model
E5ER-K

■ Accessories (Order Separately)

Terminal Cover

Descriptions	Model
Terminal Cover for E5ER	E53-COV15

Rubber Packing

Model
Y92S-P5

Note: The Rubber Packing is provided with the Digital Controller.

Specifications

■ Ratings

Supply voltage (See note 2.)	CE marking	100 to 240 VAC, 50/60 Hz	24 VAC, 50/60 Hz; 24 VDC
	UL certification	100 to 120 VAC, 50/60 Hz	24 VAC, 50/60 Hz; 24 VDC
Operating voltage range		85% to 110% of rated supply voltage	
Power consumption		17 VA max. (with maximum load)	11 VA/7 W max. (with maximum load)
Sensor input (See note 3.)		Thermocouple: K, J, T, E, L, U, N, R, S, B, W Platinum resistance thermometer: Pt100 Current input: 4 to 20 mA DC, 0 to 20 mA DC (including remote SP input) Voltage input: 1 to 5 VDC, 0 to 5 VDC, 0 to 10 VDC (including remote SP input) (Input impedance: 150 Ω for current input, approx. 1 MΩ for voltage input)	
Control output	Voltage (pulse) output	12 VDC, 40 mA max. with short-circuit protection circuit	
	Current output	0 to 20 mA DC, 4 to 20 mA DC; load: 500 Ω max. (including transfer output) (Resolution: Approx. 54,000 for 0 to 20 mA DC; Approx. 43,000 for 4 to 20 mA DC)	
	Relay output	Position-proportional control type (open, closed) N.O., 250 VAC, 1 A (including inrush current)	
Auxiliary output		Relay Output N.O., 250 VAC, 1 A (resistive load) Transistor Output Maximum load voltage: 30 VDC; Maximum load current: 50 mA; Residual voltage: 1.5 V max.; Leakage current: 0.4 mA max.	
Potentiometer input		100 Ω to 2.5 kΩ	
Event input	Contact	Input ON: 1 kΩ max.; OFF: 100 kΩ min.	
	No-contact	Input ON: Residual voltage of 1.5 V max.; OFF: Leakage current of 0.1 mA max. Short-circuit: Approx. 4 mA	
Remote SP input		Refer to the information on sensor input.	
Transfer output		Refer to the information on control output.	
Control method		2-PID or ON/OFF control	
Setting method		Digital setting using front panel keys or setting using serial communications	
Indication method		7-segment digital display and single-lighting indicator Character Height PV display: 9.5 mm; SV display: 7.2 mm; MV display: 7.2 mm	
Other functions		Depends on model.	
Ambient operating temperature		-10 to 55°C (with no icing or condensation) For 3 years of assured use: -10 to 50°C (with no icing or condensation)	
Ambient operating humidity		25% to 85%	
Storage temperature		-25 to 65°C (with no icing or condensation)	

- Note 1:** Do not use an inverter output as the power supply. (Refer to page 25.)
Note 2: The supply voltage (i.e., 100 to 240 VAC or 24 VAC/VDC) depends on the model. Be sure to specify the required type when ordering.
Note 3: The Controller is equipped with multiple sensor input. Temperature input or analog input can be selected with the input type setting switch. There is basic insulation between power supply and input terminals, power supply and output terminals, and input and output terminals.

■ Input Ranges

Platinum Resistance Thermometer, Thermocouple, Current, or Voltage Input

Input type	Platinum resistance thermometer	Thermocouple													Current		Voltage				
		Name	Pt100	K	J	T	E	L	U	N	R	S	B	W (W/Re 5-26)	mA	V					
Temperature range (°C)		850.0	1300.0	850.0	500.0	400.0	400.0	600.0	850.0	400.0	1300.0	1700.0	1700.0	1800.0	2300.0	20 to 4	20 to 0	5 to 1	5 to 0	10 to 0	
		-200.0	-150.0	-200.0	-20.0	-100.0	-20.0	-200.0	0.0	-100.0	-200.0	-200.0	0.0	0.0	100.0						0.0
Setting		0	1	2	3	4	5	6	7	8	9	10	11	12	13	14	15	16	17	18	19
Minimum setting unit (SP and alarm)		0.1°C	0.01°C	0.1°C													(Depends on scaling and number of decimal places.)				
Input type setting switch		Set to TC.PT.													Set to ANALOG						

Note: The shaded area indicates the setting status at the time of purchase.

■ Characteristics

Indication accuracy	Thermocouple input with cold junction compensation: ($\pm 0.1\%$ of PV or $\pm 1^\circ\text{C}$, whichever is greater) ± 1 digit max. (See note 1.) Thermocouple input without cold junction compensation: ($\pm 0.1\%$ FS or $\pm 1^\circ\text{C}$, whichever is smaller) ± 1 digit (See note 2.) Analog input: $\pm 0.1\%$ FS ± 1 digit max. Platinum resistance thermometer input: ($\pm 0.1\%$ of PV or $\pm 0.5^\circ\text{C}$, whichever is greater) ± 1 digit max. Position-proportional potentiometer input: $\pm 5\%$ FS ± 1 digit max.
Control mode	Standard control (heating or cooling control), heating/cooling control, standard control with remote SP (2-input models only), heating/cooling control with remote SP (2-input models only), cascade standard control (2-input models only), cascade heating/cooling control (2-input models only), proportional control (2-input models only), position-proportional control (control-valve control models only)
Influence of temperature	Thermocouple input (R, S, B, W): ($\pm 1\%$ of PV or $\pm 10^\circ\text{C}$, whichever is greater) ± 1 digit max.
Influence of voltage	Other thermocouple input: ($\pm 1\%$ of PV or $\pm 4^\circ\text{C}$, whichever is greater) ± 1 digit max. *K thermocouple at -100°C max.: $\pm 10^\circ\text{C}$ max. Platinum resistance thermometer: ($\pm 1\%$ of PV or $\pm 2^\circ\text{C}$, whichever is greater) ± 1 digit max. Analog input: ($\pm 1\%$ FS) ± 1 digit max.
Control period	0.2 to 99.0 s (in units of 0.1 s) for time-proportioning control output
Proportional band (P)	0.00% to 999.99% FS (in units of 0.01% FS)
Integral time (I)	0.0 to 3,999.9 s (in units of 0.1 s)
Derivative time (D)	0.0 to 3,999.9 s (in units of 0.1 s)
Hysteresis	0.01% to 99.99% FS (in units of 0.01% FS)
Manual reset value	0.0% to 100.0% (in units of 0.1% FS)
Alarm setting range	-19,999 to 99,999 EU (See note 3.) (The decimal point position depends on the input type and the decimal point position setting.)
Input sampling period	50 ms
Insulation resistance	20 M Ω min. (at 500 VDC)
Dielectric strength	2,000 VAC, 50/60 Hz for 1 min (between charged terminals of different polarities)
Vibration resistance (malfunction)	10 to 55 Hz, 20 m/s ² for 10 min each in X, Y, and Z directions
Shock resistance (malfunction)	100 m/s ² , 3 times each in X, Y, and Z directions
Inrush current	100 to 240-VAC models: 50 A max. 24 VAC/VDC models: 30 A max.
Weight	Controller only: Approx. 330 g; Mounting bracket: Approx. 60 g; Terminal cover: Approx. 16 g
Degree of protection	Front panel: NEMA4X for indoor use (equivalent to IP66); Rear case: IP20; Terminals: IP00
Memory protection	Non-volatile memory (number of writes: 100,000)
Applicable standards	UL 61010C-1, CSA C22.2 No. 1010-1 (Power supply voltage: 100 to 120 VAC); Pollution degree 2/Overvoltage category 2 EN 61010-1 (IEC 61010-1) (Power supply voltage: 100 to 240 VAC); Pollution degree 2/Overvoltage category 2
EMC	EMI: EN61326 Radiated Interference Electromagnetic Field Strength: EN55011 Group 1 Class A Noise Terminal Voltage: EN55011 Group 1 Class A EMS: EN61326 ESD Immunity: EN61000-4-2: 4 kV contact discharge (level 2) 8 kV air discharge (level 3) Electromagnetic Immunity: EN61000-4-3: 10 V/m (amplitude-modulated, 80 MHz to 1 GHz, 1.4 GHz to 2 GHz) (level 3) Burst Noise Immunity: EN61000-4-4: 2 kV power line (level 3) 2 kV output line (relay output) (level 4) 1 kV measurement line, I/O signal line (level 4) 1 kV communications line (level 3) Conducted Disturbance Immunity: EN61000-4-6: 3 V (0.15 to 80 MHz) (level 3) Surge Immunity: EN61000-4-5: 1 kV line to line (power line, output line (relay output)) (level 2) 2 kV line to ground (power line, output line (relay output)) (level 3) Power Frequency Magnetic Field Immunity: EN61000-4-8: 30 A/m (50 Hz) continuous field Voltage Dip/Interrupting Immunity: EN61000-4-11: 0.5 cycle, 100% (rated voltage)

- Note 1:** K-, T-, or N-type thermocouple at -100°C max.: $\pm 2^\circ\text{C} \pm 1$ digit max.
U- or L-type thermocouple: $\pm 2^\circ\text{C} \pm 1$ digit max.
B-type thermocouple at 400°C max.: No accuracy specification.
R- or S-type thermocouple at 200°C max.: $\pm 3^\circ\text{C} \pm 1$ digit max.
W-type thermocouple: ($\pm 0.3\%$ of PV or $\pm 3^\circ\text{C}$, whichever is greater) ± 1 digit max.
- 2:** U- or L-type thermocouple: $\pm 1^\circ\text{C} \pm 1$ digit
R- or S-type thermocouple at 200°C max.: $\pm 1.5^\circ\text{C} \pm 1$ digit
- 3:** "EU" (Engineering Unit) represents the unit after scaling. If a temperature sensor is used, it is either $^\circ\text{C}$ or $^\circ\text{F}$.

■ Communications Specifications

Transmission path connection	Multiple points
Communications method	RS-485 (two-wire, half duplex)
Synchronization method	Start-stop synchronization
Baud rate	9,600, 19,200, or 38,400 bps
Transmission code	ASCII
Data bit length	7 or 8 bits
Stop bit length	1 or 2 bits
Error detection	Vertical parity (none, even, odd) Block check character (BCC): CompoWay/F CRC-16: Modbus
Flow control	None
Interface	RS-485
Retry function	None
Communications buffer	217 bytes
Communications response send wait time	0 to 99 ms, Default: 20 ms

■ Program Control Functions

Number of programs (patterns)	32 (with 8 segments/program)	
Number of segments (steps)	32 (with 8 programs)	
Maximum number of segments	256	
Segment setting method	Time setting (Segment set with set point and time.) Gradient setting (Segment set with set point, gradient, and time.)	
Segment times	0 h 0 min to 99 h 59 min 0 min 0 s to 99 min 59 s 0 min 00.0 s to 99 min 59.9 s	
Alarm group number specifications	Number of groups	4
	Setting method	Set separately for each program.
Reset operation	Select either stopping control or fixed SP operation.	
Startup operation	Select continuing, resetting, manual operation, run mode, or ramp back operation.	
PID groups	Number of groups	8
	Setting method	Set separately for each program (automatic PID group selection also supported).
Alarm SP function	Select from ramp SP and target SP.	
Program status control	Segment operation	Advance, hold, and back
	Program operation	Program repetitions and program links
Wait operation	Wait method	Select from waiting at segment ends and always waiting.
	Wait width setting	Wait width upper limit and lower limit set separately for each program.
	Setting method	ON/OFF setting for each segment
Time signals	Number of outputs	6
	Number of ON/OFF operations	3 each per output
	Setting method	Set separately for each program.
Segment outputs	Number of outputs	10
	Setting method	ON/OFF set for each segment.
Program status output	Program end output (pulse width can be set) Segment number output	
Program startup operation	PV start	Select from segment 1 set point, gradient-priority PV start, and time-priority PV start.
	Standby	Standby
Operation end operation	Select from resetting, continuing control at final set point, and fixed SP control.	
Number of event inputs	10 max.	

Wiring Terminals

■ E5ER-T (Programmable Type)

E5ER-TQ4B

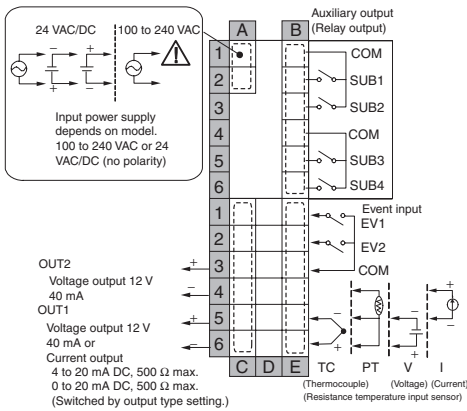

E5ER-TC4B

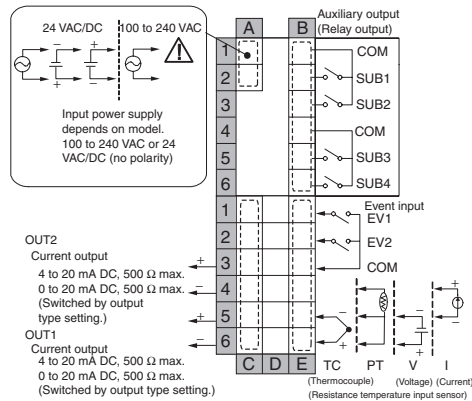

E5ER-TQC43B-FLK

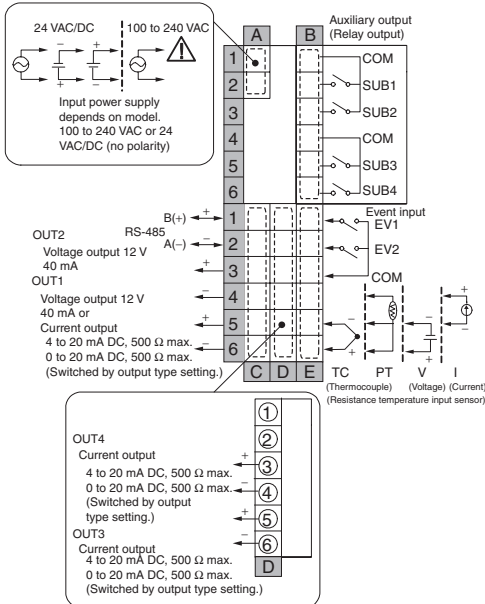

Note The power supply voltage must be 100 to 240 VAC or 24 VAC/DC for the E5ER-T to comply with CE marking requirements.
The power supply voltage must be 100 to 120 VAC or 24 VAC/DC for the E5ER-T to comply with UL requirements.

E5ER-TQT3DW-FLK (2-loop Control)

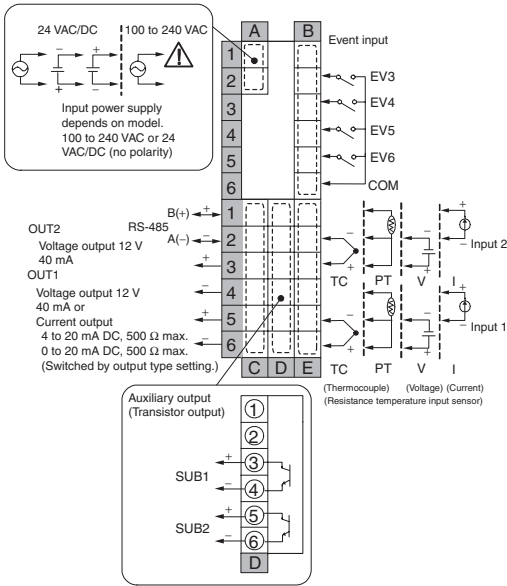

E5ER-TCT3DW-FLK (2-loop Control)

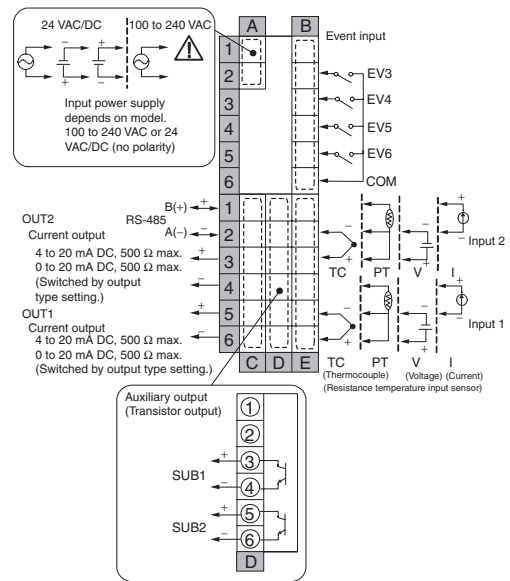

E5ER-TPRTDF

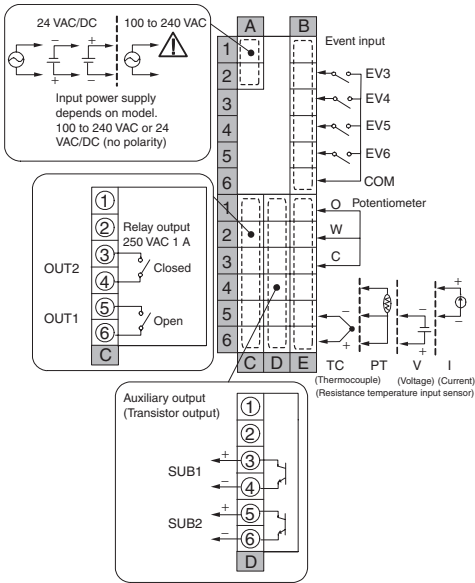

E5ER-TPRQ43F-FLK

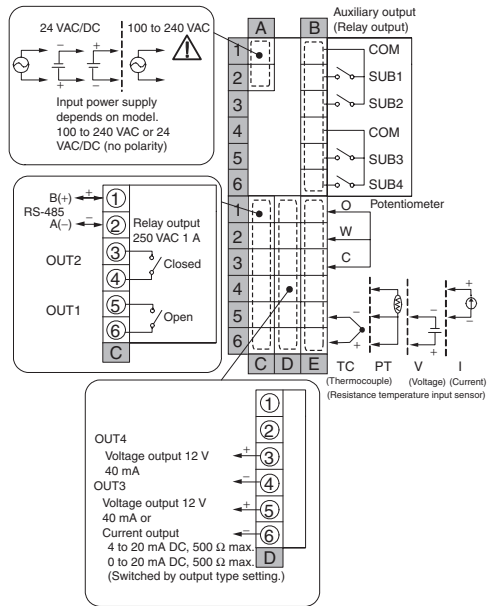

Note

The power supply voltage must be 100 to 240 VAC or 24 VAC/DC for the E5ER-T to comply with CE marking requirements.
The power supply voltage must be 100 to 120 VAC or 24 VAC/DC for the E5ER-T to comply with UL requirements.

Nomenclature

E5ER-T

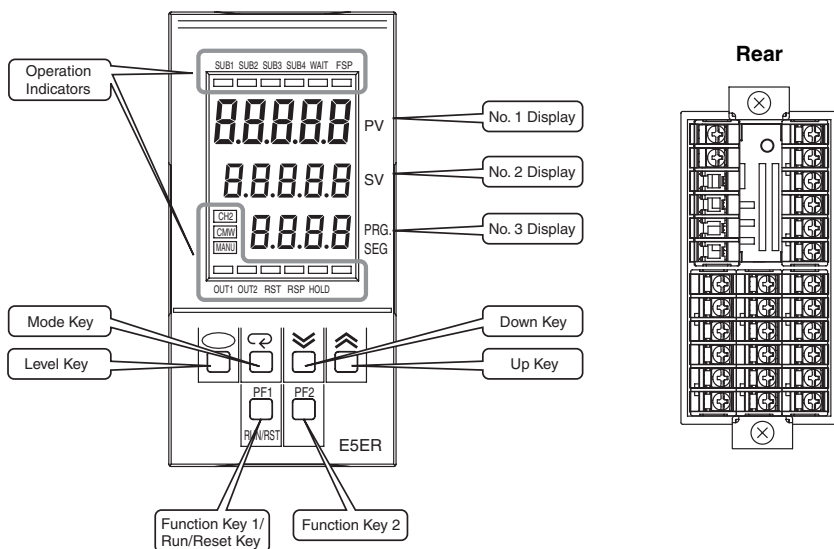

Dimensions

Note: All units are in millimeters unless otherwise indicated.

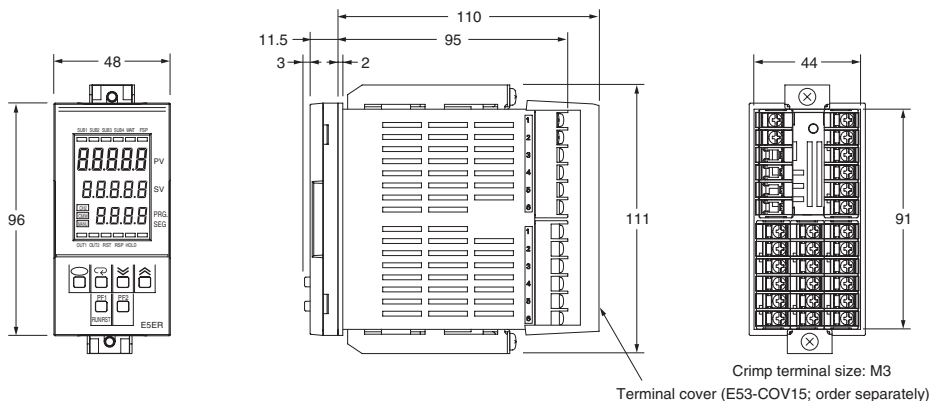
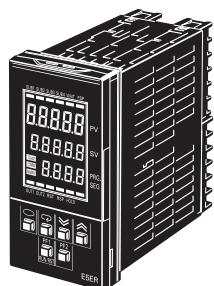

Panel Cutouts

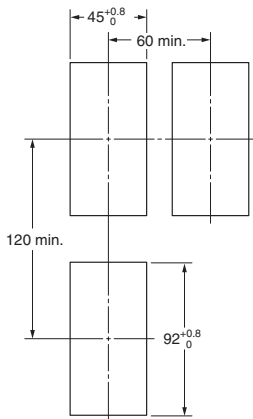

- Recommended panel thickness is 1 to 8 mm.
- Group mounting is not possible. (Maintain the specified mounting space between Controllers.)
- When two or more Controllers are mounted, make sure that the surrounding temperature does not exceed the allowable operating temperature specified in the specifications.

■ Accessories (Order Separately)

Terminal Cover

E53-COV15 (for E5ER)

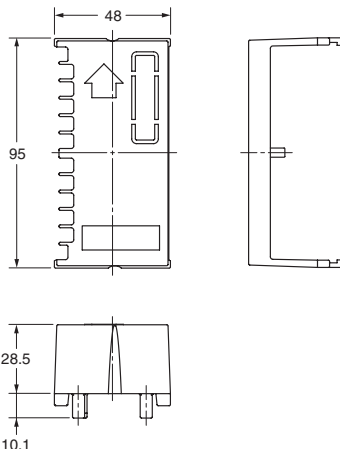
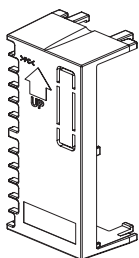

Unit Label Sheet

Refer to page 14 for details on the Y92S-L1.

Rubber Packing

Y92S-P5 (for DIN48 × 96)



Order the Rubber Packing separately if it becomes lost or damaged. (Refer to page 16.) (Deterioration, shrinking, or hardening of the rubber packing may occur depending on the operating environment. Therefore, periodic replacement is recommended to ensure the level of waterproofing specified in NEMA4. The time for periodic replacement depends on the operating environment. Be sure to confirm this point at your site. Consider one year a rough standard. OMRON shall not be liable for the level of water resistance if the customer does not perform periodic replacement.)

ALL DIMENSIONS SHOWN ARE IN MILLIMETERS.

To convert millimeters into inches, multiply by 0.03937. To convert grams into ounces, multiply by 0.03527.

Precautions

⚠ CAUTION

Do not touch the terminals while power is being supplied. Doing so may occasionally result in minor injury due to electric shock.



Do not touch the terminals or the electrical components or patterns on the PCB within 1 minute after turning OFF the power supply. Doing so may occasionally result in minor injury due to electric shock.



Do not allow pieces of metal, wire clippings, or fine metallic shavings or filings from installation to enter the product. Doing so may occasionally result in electric shock, fire, or malfunction.



Do not use the product in locations where flammable or explosive gases are present. Doing so may occasionally result in minor or moderate explosion, causing minor or moderate injury, or property damage.



Tighten the screws on the terminal block to the following specified torque. Loose screws may occasionally cause fire, resulting in minor or moderate injury, or damage to the equipment.



Terminal block screws: 0.40 to 0.56 N·m

Perform correct setting of the product according to the application. Failure to do so may occasionally cause unexpected operation, resulting in minor or moderate injury, or damage to the equipment.



A malfunction in the Product may occasionally make control operations impossible or prevent alarm outputs, occasionally resulting in property damage to the system or equipment connected to the Product. To maintain safety in the event of malfunction of the Product, take appropriate safety measures, such as installing a monitoring device in a separate system.



Do not use the equipment for measurements within measurement categories II, III, or IV (according to IEC61010-1). Doing so may occasionally cause unexpected operation, resulting in minor or moderate injury, or damage to the equipment. Use the equipment for measurements only within the measurement categories for which the product is designed.



The service life of the output relays depends on the switching capacity and switching conditions. Consider the actual application conditions and use the product within the rated load and electrical service life. Using the product beyond its service life may occasionally result in contact welding or burning.



Do Not disassemble, modify, or repair the product or touch any of the internal parts. Minor electric shock, fire, or malfunction may occasionally occur.



■ Precautions for Safe Use

- Use and store the Digital Controller in the range of specifications for ambient temperature and humidity. The service life will decrease due to increased internal temperature if multiple Digital Controllers are mounted closely side by side or one on top of the other. If this type of mounting is used, use forced cooling, e.g., use a fan to blow air onto the Digital Controllers.
- Do not prevent heat dissipation by obstructing the periphery of the Digital Controller. Do not block the vents on the Digital Controller unit.
- The supplied power voltage and load must be within the rated and specified ranges.
- Be sure to confirm the name and polarity for each terminal before wiring the terminal block.
- Do not connect anything to unused terminals.
- Use the specified size of crimp terminals (M3, width: 5.8 mm max.) to wire the terminal block. When connecting bare wires, use copper stranded or solid wires, and use AWG22 (cross-sectional area of 0.326 mm²) to AWG14 (cross-sectional area of 2.081 mm²) for the power supply terminals and AWG28 (cross-sectional area of 0.081 mm²) to AWG16 (cross-sectional area of 1.309 mm²) for other terminals. (Length of exposed wire: 6 to 8 mm)
- Ensure that the rated voltage is attained within 2 seconds after turning ON the power.
- Turn OFF the power first when you need to draw out the Digital Controller. Do Not touch the terminals or the electronic components, or subject them to physical shock. When inserting the Digital Controller, do not allow the electronic components to contact the case.
- Do not remove the inner circuit board.
- The output may turn OFF when shifting to certain levels. Take this into consideration when performing control.
- Allow a warm-up time of at least 30 minutes.
- To prevent inductive noise, separate the Digital Controller terminal block wiring from power lines that carry high voltages or high currents. Also, do not wire power lines together with or parallel to the Digital Controller wiring. Using shielded cables and separate conduits or ducts is recommended. Attach a surge suppressor or noise filter to peripheral devices that generate noise (in particular, motors, transformers, solenoids, magnetic coils, or other equipment that has an inductive component). When a noise filter is used at the power supply, first check the voltage or current, and attach the noise filter as close as possible to the product. Allow as much space as possible between the product and devices that generate powerful high frequencies (e.g., high-frequency welders, high-frequency sewing machines) or surge.
- Install a switch or circuit breaker that allows the operator to immediately turn OFF the power, and label suitably.
- The product is designed for indoor use only. Do not use the product outdoors or in any of the following locations.
 - Locations where dust or corrosive gas is present (in particular, sulfur or ammonia gases)
 - Locations where condensation or ice may form
 - Locations directly exposed to sunlight
 - Locations subject to strong shocks or vibration
 - Locations where water or oil may splatter on the Digital Controller
 - Locations directly exposed to radiant heat from heating equipment
 - Locations subject to sudden or extreme changes of temperature
- Do not use paint thinner or similar chemical to clean with. Use standard grade alcohol.

- 16. Some inverters are labeled as having an output frequency of 50/60 Hz. Smoke or burning, however, may occur due to increased temperature in the Digital controller. Do not use an inverter output as the power supply for the Digital Controller.

■ Precautions for Correct Use

Service Life

Use the product within the following temperature and humidity ranges:

Temperature: -10 to 55°C (with no icing or condensation)

Humidity: 25% to 85%

When the product is installed inside a control panel, make sure that the temperature around the product, not the temperature around the control panel, does not exceed 55°C.

The service life of this product and similar electronic devices is determined not only by the number of switching operations of relays but also by the service life of internal electronic components. Component service life is affected by the ambient temperature: the higher the temperature becomes, the shorter the service life becomes and, the lower the temperature becomes, the longer the service life becomes. Therefore, the service life can be extended by lowering the temperature of the product.

Be sure to install the product according to the specified conditions. Otherwise, the heat generated by the product will cause the internal temperature to rise, shortening the service life. If necessary, cool the product using fans or other means of air ventilation.

When providing forced cooling, however, be careful not to cool down the terminals sections alone to avoid measurement errors.

Noise Countermeasures

To prevent inductive noise, separate the wiring for the product's terminal block and connector from high-voltage, high-current power lines. Do not run the wiring parallel to or in the same cable as power lines. The influence of noise can also be reduced by using separate wiring ducts or shield lines.

Install surge absorbers or noise filters in devices near the product that generate noise (in particular, devices with an inductance component, such as motors, transformers, solenoids, and magnetic coils).

If a noise filter is used for the power supply, check the voltage and current, and install the noise filter as close as possible to the product.

Separate the product as far as possible from devices generating strong high-frequency noise (e.g., high-frequency welders and high-frequency sewing machines) or surges.

Measurement Accuracy

When extending the thermocouple lead wire, be sure to use a compensating wire that matches the thermocouple type.

When extending the lead wire of the platinum resistance thermometer, be sure to use wires that have low resistance, and make sure that the resistances of the three lead wires are the same.

If the measurement accuracy is low, check whether the input shift is set correctly.

Waterproofing

The degree of protection is as shown below.

Front panel	NEMA 4X indoor use (equivalent to IP66)
Rear case	IP20
Terminals	IP00

Warranty and Application Considerations

Read and Understand This Catalog

Please read and understand this catalog before purchasing the products. Please consult your OMRON representative if you have any questions or comments.

Warranty and Limitations of Liability

WARRANTY

OMRON's exclusive warranty is that the products are free from defects in materials and workmanship for a period of one year (or other period if specified) from date of sale by OMRON.

OMRON MAKES NO WARRANTY OR REPRESENTATION, EXPRESS OR IMPLIED, REGARDING NON-INFRINGEMENT, MERCHANTABILITY, OR FITNESS FOR PARTICULAR PURPOSE OF THE PRODUCTS. ANY BUYER OR USER ACKNOWLEDGES THAT THE BUYER OR USER ALONE HAS DETERMINED THAT THE PRODUCTS WILL SUITABLY MEET THE REQUIREMENTS OF THEIR INTENDED USE. OMRON DISCLAIMS ALL OTHER WARRANTIES, EXPRESS OR IMPLIED.

LIMITATIONS OF LIABILITY

OMRON SHALL NOT BE RESPONSIBLE FOR SPECIAL, INDIRECT, OR CONSEQUENTIAL DAMAGES, LOSS OF PROFITS, OR COMMERCIAL LOSS IN ANY WAY CONNECTED WITH THE PRODUCTS, WHETHER SUCH CLAIM IS BASED ON CONTRACT, WARRANTY, NEGLIGENCE, OR STRICT LIABILITY.

In no event shall the responsibility of OMRON for any act exceed the individual price of the product on which liability is asserted.

IN NO EVENT SHALL OMRON BE RESPONSIBLE FOR WARRANTY, REPAIR, OR OTHER CLAIMS REGARDING THE PRODUCTS UNLESS OMRON'S ANALYSIS CONFIRMS THAT THE PRODUCTS WERE PROPERLY HANDLED, STORED, INSTALLED, AND MAINTAINED AND NOT SUBJECT TO CONTAMINATION, ABUSE, MISUSE, OR INAPPROPRIATE MODIFICATION OR REPAIR.

Application Considerations

SUITABILITY FOR USE

OMRON shall not be responsible for conformity with any standards, codes, or regulations that apply to the combination of products in the customer's application or use of the products.

Take all necessary steps to determine the suitability of the product for the systems, machines, and equipment with which it will be used.

Know and observe all prohibitions of use applicable to this product.

NEVER USE THE PRODUCTS FOR AN APPLICATION INVOLVING SERIOUS RISK TO LIFE OR PROPERTY WITHOUT ENSURING THAT THE SYSTEM AS A WHOLE HAS BEEN DESIGNED TO ADDRESS THE RISKS, AND THAT THE OMRON PRODUCTS ARE PROPERLY RATED AND INSTALLED FOR THE INTENDED USE WITHIN THE OVERALL EQUIPMENT OR SYSTEM.

Disclaimers

PERFORMANCE DATA

Performance data given in this catalog is provided as a guide for the user in determining suitability and does not constitute a warranty. It may represent the result of OMRON's test conditions, and the users must correlate it to actual application requirements. Actual performance is subject to the OMRON *Warranty and Limitations of Liability*.

CHANGE IN SPECIFICATIONS

Product specifications and accessories may be changed at any time based on improvements and other reasons. Consult with your OMRON representative at any time to confirm actual specifications of purchased product.

DIMENSIONS AND WEIGHTS

Dimensions and weights are nominal and are not to be used for manufacturing purposes, even when tolerances are shown.

ALL DIMENSIONS SHOWN ARE IN MILLIMETERS.

To convert millimeters into inches, multiply by 0.03937. To convert grams into ounces, multiply by 0.03527.

Cat. No. H150-E1-01 **In the interest of product improvement, specifications are subject to change without notice.**

OMRON Corporation

Industrial Automation Company

Control Devices Division H.Q.

Analog Controller Division

Shiokoji Horikawa, Shimogyo-ku,

Kyoto, 600-8530 Japan

Tel: (81)75-344-7080/Fax: (81)75-344-7189

Printed in Japan

0606-1M (0606) (C)